

## YOU HAVE MADE A WISE SELECTION...

in choosing a Da-Lite projection screen designed and engineered to produce the sharpest, most pleasing pictures with maximum convenience.

**PROTECT YOUR SCREEN** by keeping it rolled in its protective case when not in use. Always examine both front and back of surface before re-rolling into case to make certain screen is free of dust, dirt or other foreign matter. Use a very soft duster brush gently to remove foreign particles.

## INSTALLATION

Care in mounting and care in correct operation will mean a long and satisfactory life for your Da-Lite wall/ceiling screen. Locate the screen where the audience can best see it and where other furnishings in the room permit. Mount the screen so that bottom of picture surface, when fully extended, will be above heads of viewers.

## BUILT-IN HANGERS

Da-Lite wall/ceiling screens may be mounted on wall, map rails, suspended from ceiling or extension brackets. Wall screens must be mounted level and with the case-back parallel to the wall.

### FOR WALL MOUNTING –

Use the keyhole slot at the back of the hanging bracket for flush wall suspension. Position screws or other fasteners into wall and hang screen by using slots.

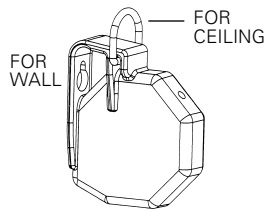

### FOR MAP RAIL MOUNTING –

Use keyhole slots in flat brackets. Do not use "D" rings.

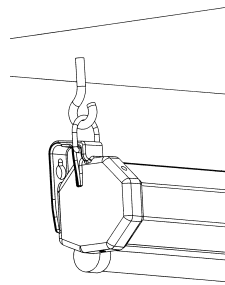

### FOR CEILING SUSPENSION

If the screen is to be ceiling mounted, two screw hooks placed in a beam or other solid surface will do the job. For dropped ceilings, Da-Lite's T-Bar Scissors Clip may be purchased.

NOTE: Whichever method is used, the screen should be free to swing forward and back and not be anchored rigidly. Mount the screen so that bottom of picture surface, when fully extended, will be above heads of viewers.

## OPERATING INSTRUCTIONS

### TO LOWER PICTURE SURFACE

Pull screen down all the way. HESITATE – then allow screen to retract VERY SLOWLY until it locks in place.

### TO RAISE PICTURE SURFACE

Pull down on the pull bail, then release quickly. The screen will retract gently into the case.

### TO ADJUST RETRACTION SPEED

Use a large flat screwdriver to turn the adjustment knob on the right end of the screen. To increase the travel speed turn counterclockwise. To decrease the travel speed turn clockwise. Adjustments should be made in half turn increments and travel speed checked before adjusting further.

**NOTE:** This feature is not available on some large screen sizes.

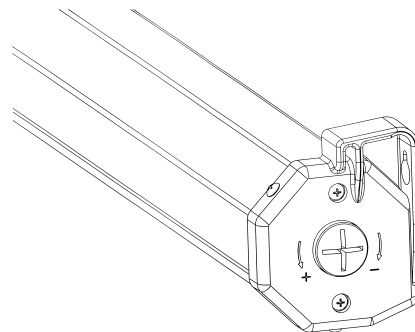

## SCREEN ACCESSORIES

### WALL BRACKETS

Da-Lite No. 6 and No. 11 Non-adjustable wall brackets and No. 23 adjustable extension wall brackets are ideal for keystone elimination, chalkboard clearance, or corner mounting. The screen brackets should be fastened to the studding or other solid surface and not in the plaster only. Suspend screen from "D" rings.

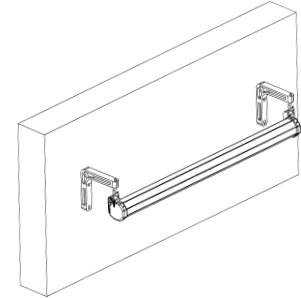

### No. 23 ADJUSTABLE WALL BRACKETS

Screen can be extended 18<sup>3</sup>/<sub>4</sub>", 20" or 24" from wall by wing nut and bolt adjustment.

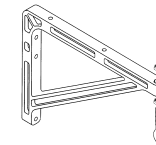
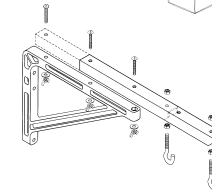

### No. 11 WALL BRACKETS

Screen can be extended 10" or 14" from wall by changing position of bracket.

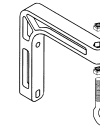

### No. 6 WALL BRACKETS

Screen can be extended 6" from wall.

### T-BAR SCISSORS CLIP For Dropped Ceilings

50 lb. max. load capacity.

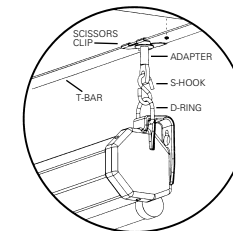

### TILT LOCK

#### For Keystone Elimination

Holds back bottom of screen in tilted position to eliminate keystoneing.

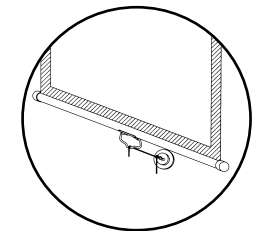

**QUALITY FEATURES FOR BETTER PICTURES,  
EASIER OPERATION, LONGER LIFE**

- Exclusive Camlok Roller System
- Attractively styled
- Easily installed
- Economically priced
- Completely self-storing
- Ideal for churches, schools, family centers and industrial training rooms.

For the finest in slide, film, and video projection

**DA-LITE IS MORE  
THAN PROJECTION SCREENS**

Da-Lite Tripod, Wall &  
Ceiling and Electric Screens

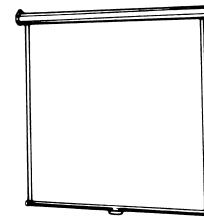

Da-Lite Overhead and  
Opaque Projectors

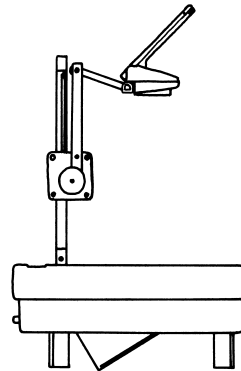

Da-Lite  
Model 5000 Portable

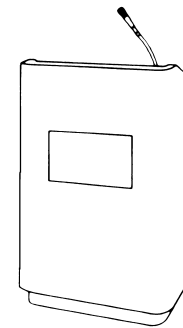

Da-Lite Lecterns  
Communications  
Cabinets



Da-Lite  
Project-O-Stands  
and Easels

**DA-LITE**

**WALL/CEILING  
PROJECTION SCREENS**

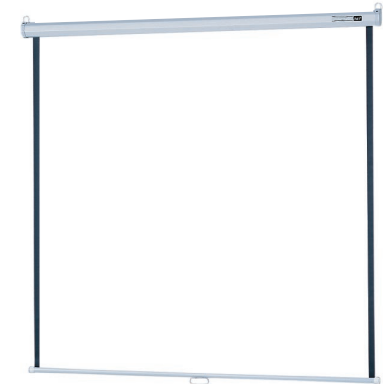

**OPERATING INSTRUCTIONS  
FOR**

**MODEL B<sup>®</sup> WITH CSR  
(CONTROLLED SCREEN RETURN)**

**DA-LITE SCREEN  
COMPANY, INC.**  
3100 North Detroit Street  
Post Office Box 137  
Warsaw, IN 46581-0137  
Phone: 219/267-8101  
800-622-3737  
Fax: 219/267-7804  
[http:// www.da-lite.com](http://www.da-lite.com)  
e-mail: [info@da-lite.com](mailto:info@da-lite.com)